

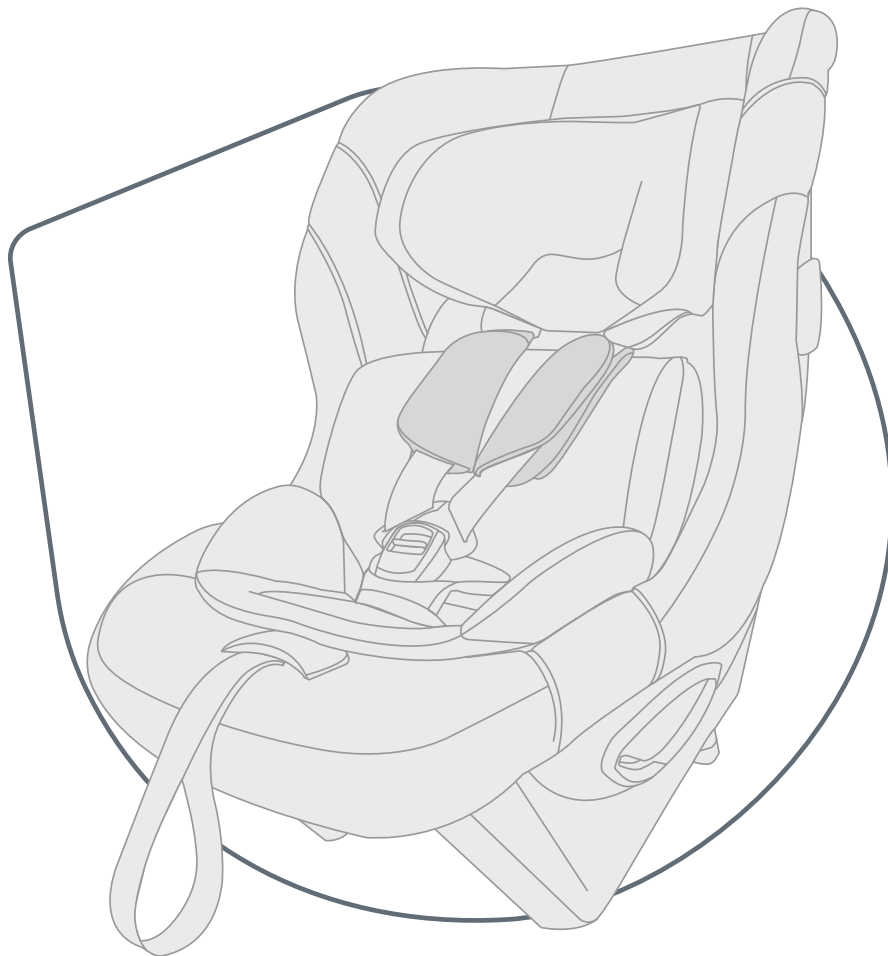

SAFE-WAY M

USER GUIDE



EN-UK

BRITAX RÖMER Child Safety EMEA

www.britax-roemer.com | contact@britax.com

Contents

1	Symbol explanation.....	3
2	Safety.....	4
2.1	User Guide.....	4
2.2	Intended use.....	4
2.3	Misuse.....	4
2.4	Safety informations.....	4
3	Settings.....	6
3.1	Adjust headrest.....	6
3.2	Fasten spacer.....	6
3.3	Use the seat insert.....	6
4	Use in the vehicle.....	8
4.1	Select seat.....	8
4.2	Prepare eyes.....	8
4.3	Secure child seat.....	11
4.4	Loosen child seat.....	15
5	Buckling in and unbuckling.....	16
5.1	Buckle child in.....	16
5.2	Check before every use.....	17
5.3	Unbuckle child.....	17
6	Cleaning and maintenance.....	18
6.1	Harness buckle.....	18
6.2	Cover.....	18
6.3	Shoulder pads.....	19
6.4	Change battery.....	19
6.5	Troubleshooting.....	20
7	Storage and disposal.....	21
7.1	Storage.....	21
7.2	Disposal.....	21
8	Contact.....	22

1 Symbol explanation

Warning signs

Warning signs are used in this user guide in order to advise of potential danger situations. The warning signs inform you about the following items:

- Level of danger,
- Type and source of danger,
- Consequences if disregarded,
- Measures to prevent danger.

Warning signs are shown as follows:

WARNING

Type and source of danger

Consequences if disregarded

- ▶ Measures to prevent danger
-

Level of danger	Meaning
DANGER!	Highlights dangerous situations which, if not avoided, lead to serious injuries or death.
WARNING!	Indicates a dangerous situation which, if not avoided, can lead to serious injuries or death.
CAUTION!	Indicates a dangerous situation which, if not avoided, can lead to slight to moderate injuries.
NOTE	Indicates actions that can lead to damage.

Signs and symbols

-  Highlights important information for you.
-

Specific actions

- ▶ ...

Action

1. Demands action from you.
2. Defined sequence of actions.
3. ...

Result of action

- ✓ There is where you will find the result of a sequence of actions.

2 Safety

2.1 User Guide

This user guide is a component of the product and contributes to its safe use. Non-compliance may lead to serious or even fatal injuries. If there are uncertainties, do not use the product and immediately contact your retailer.

- ▶ Read the operating instructions.

2.2 Intended use

This product has been designed, tested and approved corresponding to the requirements of UN R129/03.

This product is designed for securing a child in a vehicle. It is approved for the following details:

Designation	Value
Body height	61 – 125 cm
	 Use the seat insert if the child is between 61 and 87 cm.
Body weight	≤ 36 kg

Use the product on forward-facing car seats.

This approval is invalidated if you make any modifications to this product. Changes may only be made by the manufacturer. The stickers on the product are an important component of the product.

- ▶ Do not make any changes to the product.
- ▶ Do not remove any stickers from the product.

2.3 Misuse

- ▶ Do not use the product as a toy.
- ▶ Do not use the product as a chair outside the vehicle, not even to test.
- ▶ Only secure the child seat with fastening points described in these operating instructions.
- ▶ Never secure the product with a 2-point seat belt.
- ▶ Ensure that the product is not trapped between hard objects (car door, seat rails, etc.).
- ▶ Keep product away from moisture, wet conditions, liquids, dust and salt spray.
- ▶ Do not lean heavy objects on the product.
- ▶ Never lubricate or oil parts of the product.
- ▶ Sensitive car seat covers may be damaged. Use the Britax Römer child seat base. These are available separately.

2.4 Safety informations

WARNING

Risk of injury from damaged child seat

In the event of an accident, the child seat may be damaged without the damage being immediately visible. Serious injuries may result from another accident.

- ▶ Never use a damaged product.
- ▶ Replace the product after an accident.
- ▶ Have a damaged product inspected by Britax Römer (even if it has fallen onto the ground).
- ▶ Regularly check all the important parts for damage.
- ▶ Ensure that all mechanical components work properly.

WARNING

Risk of burns from hot components

Components of the product may become hot in direct sunlight. Children's skin is sensitive and maybe harmed as a result.

- ▶ Protect the product against intensive direct sunlight when not in use.

WARNING

Danger to life due to the effects of heat or cold.

If children are exposed to the effects of heat or cold for a longer period, there is a risk of injury or even death.

- ▶ Never leave children unsupervised in the vehicle.

WARNING

Risk of injury when boarding and exit

It can be dangerous to stand on the road-side of the vehicle.

- ▶ Secure and remove the child seat from the footpath-side.
- ▶ Secure and remove the child from the footpath-side.

WARNING

Risk of injury from unsecured objects

In case of an emergency stop or accident, unsecured objects or people may cause injury to other occupants in the vehicle.

- ▶ Fasten the product as described in the user guide.
 - ▶ Secure backrests of the car seat (e.g. engage foldable rear).
 - ▶ Fasten or remove all heavy or sharp-edged objects in the vehicle.
 - ▶ Ensure that everyone in the vehicle has their seatbelts fastened.
 - ▶ Ensure that the product is always secured when it is in the vehicle, even if no child is being transported.
-

3 Settings

3.1 Adjust headrest



1 Headrest

1. Check that the headrest 1 is adjusted correctly.

- ① If the shoulder straps are at or slightly below the shoulder height of the child, the headrest is positioned correctly.
 - ▶ If the headrest is not positioned correctly, perform the following steps.

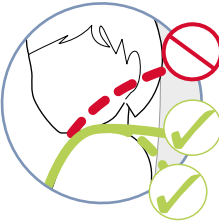
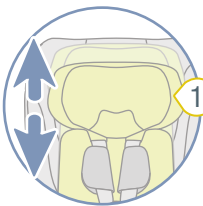
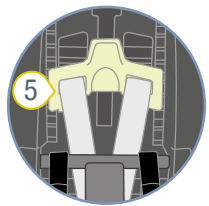
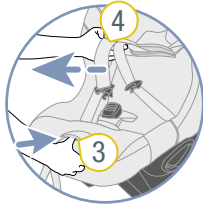
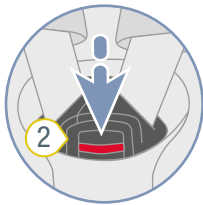
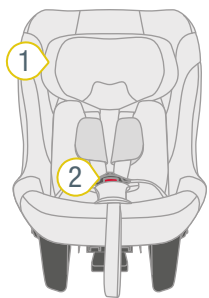

- 1 Headrest
- 2 Harness buckle
- 3 Adjustment button
- 4 Shoulder straps
- 5 Release lever

2. Open the harness buckle 2 by pressing the red button.
3. To loosen the belt, press the adjustment button 3 and pull both shoulder straps 4 forwards at the same time.

- ① The shoulder pads are **not** connected to the shoulder straps. If you pull on the shoulder pads, the belt is **not** loosened. Only pull on the shoulder straps.

- 4. Open the release lever 5.
 - ✓ The headrest is unlocked.
- 5. Slide the headrest 1 to the correct shoulder height.
- 6. Let go of the release lever 5.
- 7. Check that the headrest 1 is locked correctly in place by pushing the headrest 1 down.
 - ✓ Headrest 1 is adjusted correctly.
 - ✓ Headrest 1 is locked in place.

3.2 Fasten spacer

- ① The spacer is not included in the extent of delivery. You can purchase the spacer separately as an accessory.
- ① The spacer provides additional space legroom for your child. Use of the space depends on the space available in the vehicle.

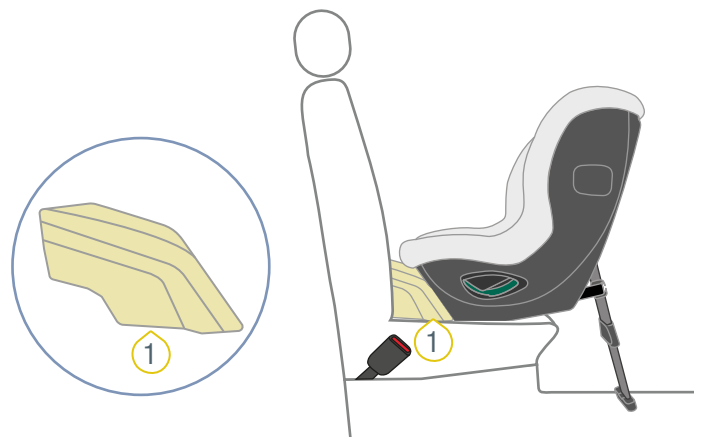

1 Spacer

- 1. Clamp the spacer 1 to the child seat.
- 2. Continue with the chapter "Positioning the child seat".

3.3 Use the seat insert

- ① Use the seat insert if the child is between 61 and 87 cm.

3.3.1 Attach seat insert

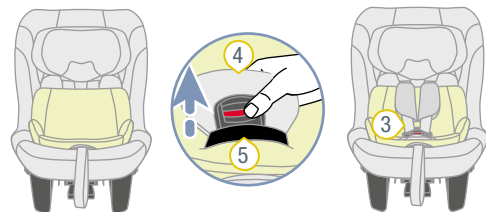
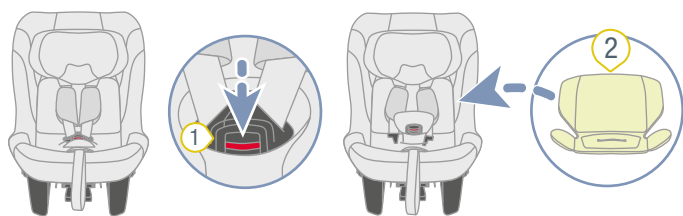

- ① Harness buckle
- ② Seat insert
- ③ Shoulder strap
- ④ Padded crotch
- ⑤ Recess

1. Open the harness buckle **1** by pressing the red button.
2. Place the seat insert **2** into the child seat.

i Note the orientation of the seat insert. You can use the wash label as a guide. The wash label is on the back of the seat insert and should face the child seat.

3. Pass the harness buckle **1** and the padded crotch **4** through the recess **5** on the lower section of the seat insert **2**.
4. Place both shoulder straps **3** over the seat insert **2**.

3.3.2 Remove seat insert

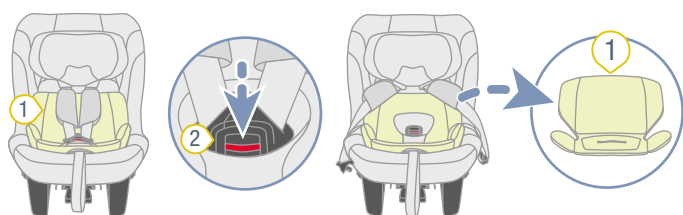

- ① Seat insert
- ② Harness buckle

1. Open the harness buckle **1** by pressing the red button.
2. Remove the seat insert **2**.

4 Use in the vehicle

4.1 Select seat

1. Note and observe the vehicle handbook.

- ① Only car seats arranged in the direction of travel are approved for use.

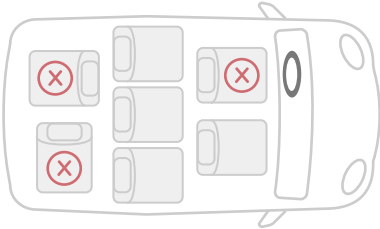

2. Select a suitable seat.

- ① Car seats, which have been tested and approved by us, are suitable. You can find these in our model list. You can find the model list at: <https://manuals.britax.com/product/p1050-1>

- ① The list of vehicle models has been created in accordance with the requirements of Standard UN R129 and contains the vehicle models, in which the product has been tested as at the date of publication according to the instructions contained in the user guide. However, the information about a specific vehicle model is not a guarantee that the product can be installed in the stated vehicle and customers are advised that they should consult the user guide about the correct installation of the product.

- ① If the desired vehicle is not included in the model list, please feel free to contact us (See "Contact", Page 22).

3. We recommend positioning the car seats as follows.

When using on the front seat:

- Slide the front seat as far back as possible.

When using on the rear seat:

- Slide the back seat as far back as possible.
- Slide the front seat as far forwards as possible.

4.2 Prepare eyes

- ① The carabiner on the lower strap must be hooked into suitable eyes. These eyes may already be present in the vehicle. If the vehicle does not have suitable eyes, the retaining straps have to be fastened. The retaining straps provide eyes for fastening the lower strap.

1. Check that the selected car seat has one of the following fastening variants.

TIP You can find more information in the vehicle's manual

– Vehicle eye

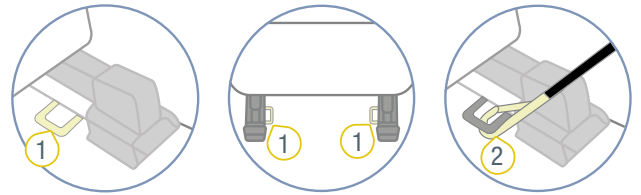

① Vehicle eye

② Carabiner

– Strap on rail (rails with space to the vehicle floor)

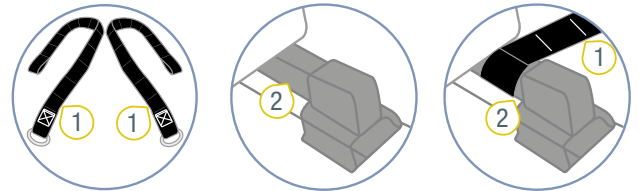

① Strap

② Rail

– Strap on seat joint (car seat with seat fold)

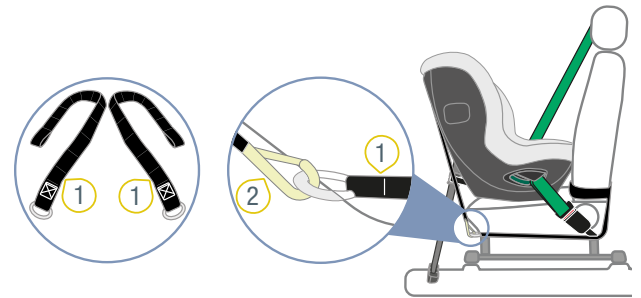

① Strap

② Carabiner

2. Choose a fastening option available in the vehicle.

4.2.1 Use vehicle eyes.

ⓘ If there are already eyes for the selected car seat, a strap does not have to be fastened. The carabiners are hooked directly to the eyes. The fastening of the carabiners depends on the selected car seat place. We distinguish between the following car seat places.

► Single seat

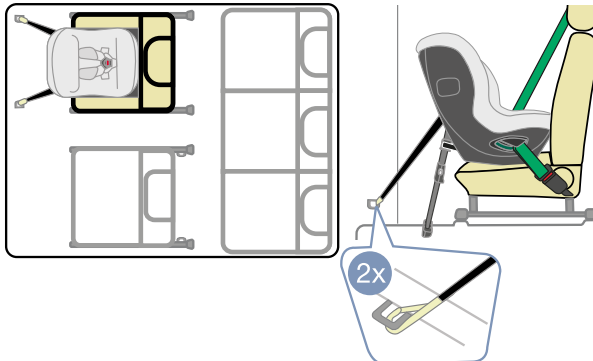

► Middle seat of a bench seat

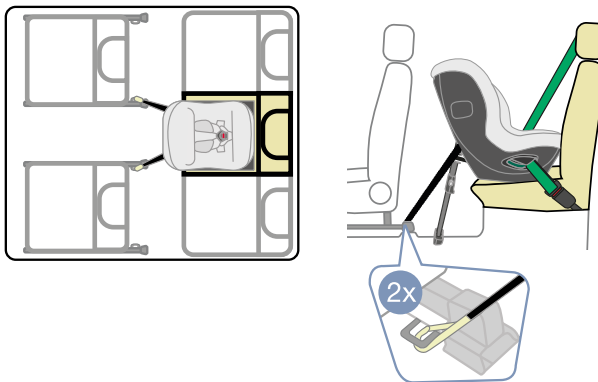

► Outer seat of a bench seat

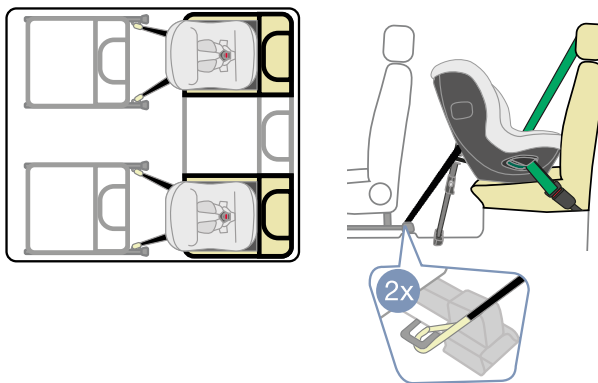

ⓘ The fastening of the straps depends on the selected car seat place. We distinguish between the following car seat places.

– Single seat

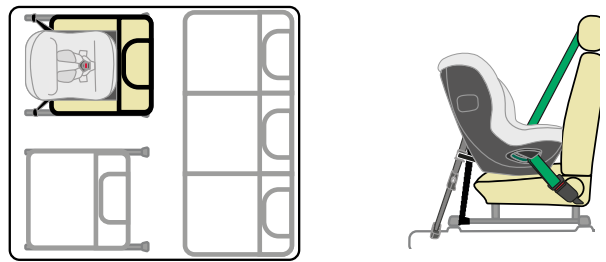

– Middle seat of a bench seat

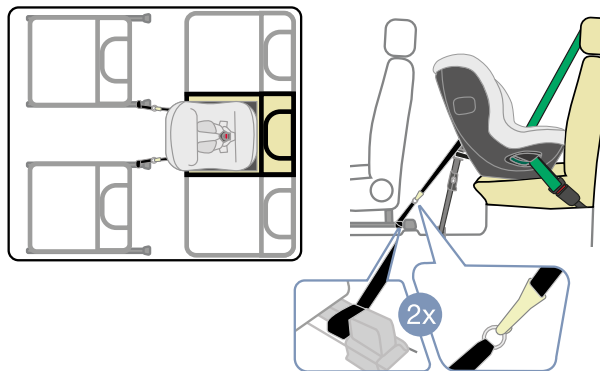

– Outer seat of a bench seat

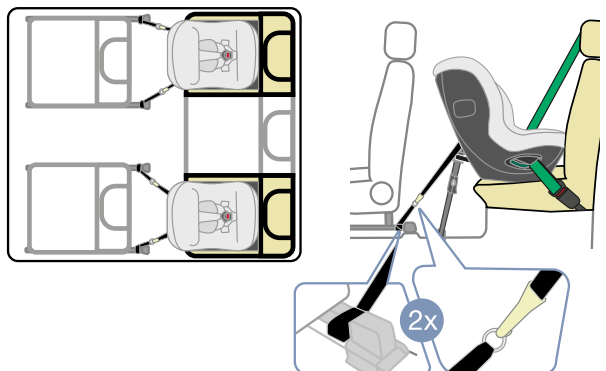

4.2.2 Fasten strap to the rail

ADVICE

Material damage as a result of strap

If the strap is passed over plastic parts or electrical components of the vehicle, these may be damaged.

► Make sure that the strap is not passed over plastic parts or electrical components of the vehicle.

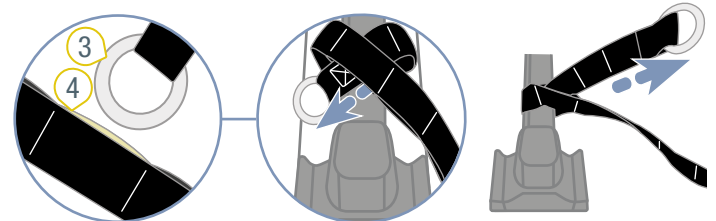
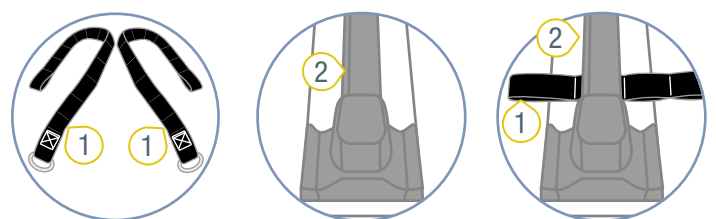

① Strap

② Rail

③ Metal ring

④ Loop

1. Check which fastening variant the car seat allows.
 2. Pass the strap 1 around the rail 2.
 3. Pass the metal ring 3 through one of the loops 4.
- TIP** The narrower the strap around the strap, the better.
4. Pull the loop tight
- ✓ Both straps are ready.

4.2.3 Fasten strap to the seat fold

ADVICE

Material damage as a result of strap

If the strap is passed over plastic parts or electrical components of the vehicle, these may be damaged.

- ▶ Make sure that the strap is not passed over plastic parts or electrical components of the vehicle.

❗ The fastening of the straps depends on the selected car seat place. We distinguish between the following car seat places.

- Single seat

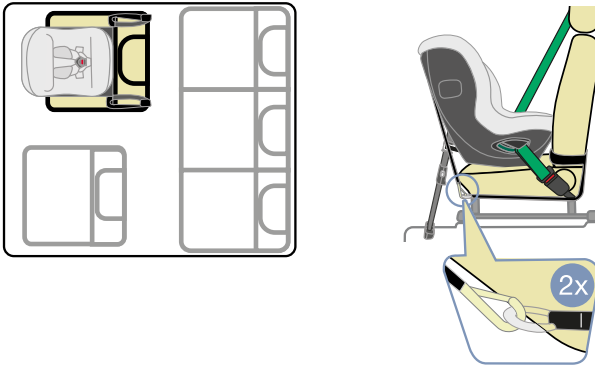

- Middle seat of a bench seat

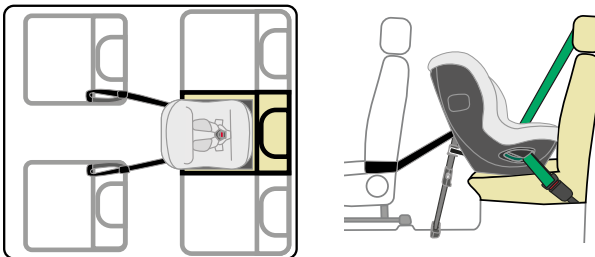

- Outer seat of a bench seat

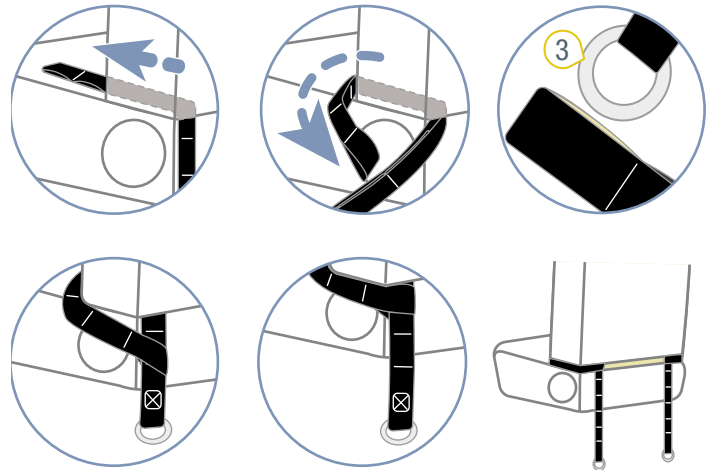
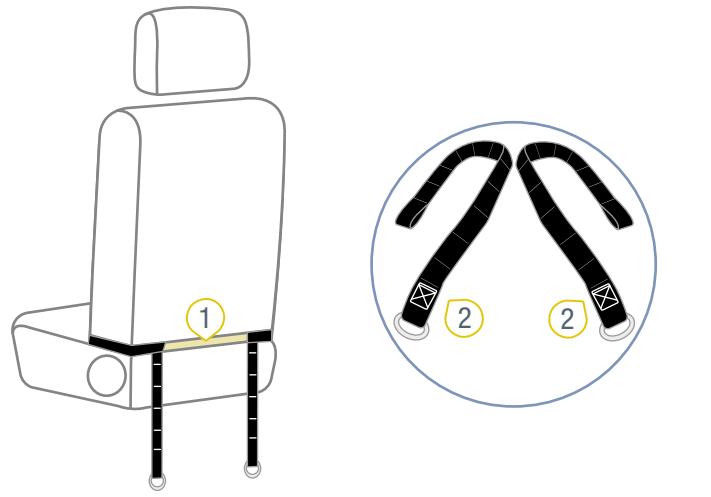
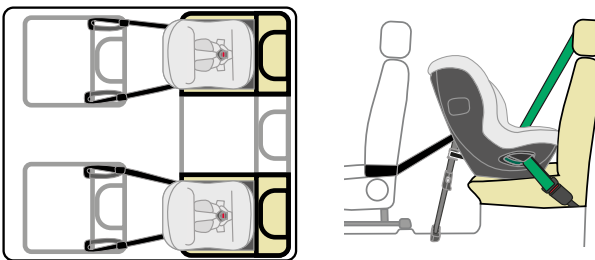

① Seat fold

③ Metal ring

② Strap

1. Check which fastening variant the car seat allows.
2. Pass the strap 2 through the seat fold 1.
3. Pass the strap 2 around the seat fold.
4. Pass the metal ring 3 through one of the loops.

TIP The narrower the strap around the seat joint, the better.

5. Pull the loop tight
- ✓ Both straps are ready.

4.3 Secure child seat

4.3.1 Position child seat



- ① Child seat
- ② Support leg
- ③ Adjustment buttons

1. Optional: Position the spacer (See "Fasten spacer", Page 6).

ⓘ The following describes the fastening of the child seat without the spacer, but also applies to use with the spacer.

2. Place the child seat **1** on the selected car seat.
3. Fold the support leg **2** completely away from the child seat.
4. Press both adjustment buttons **3**.
 - ✓ The support leg extends to the floor.
 - ✓ Both adjustment buttons **3** audibly lock in place.
5. Make sure that the child seat is leaning against the backrest of the car seat.

4.3.2 Prepare child seat

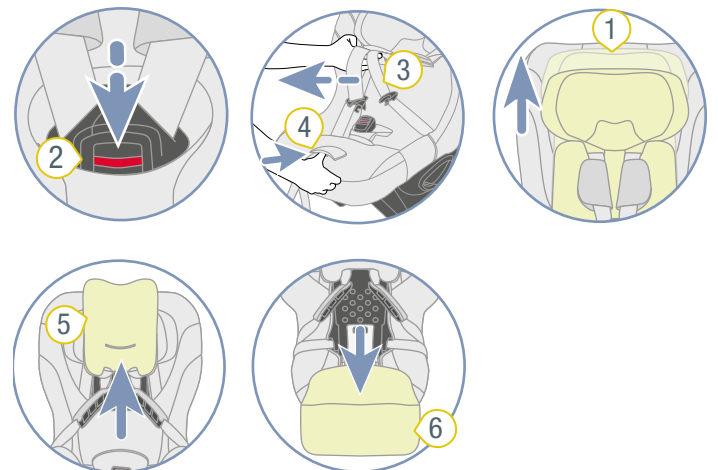
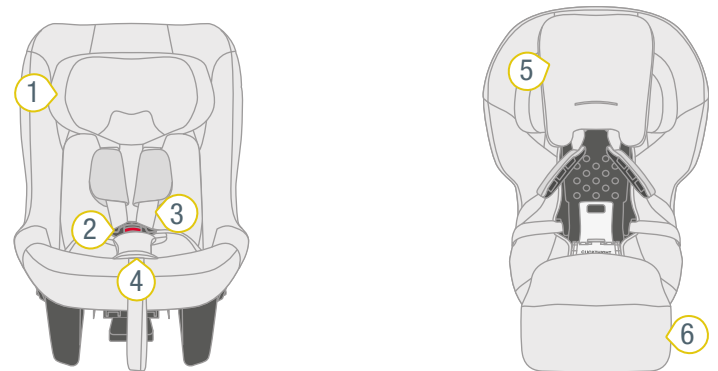

- ① Headrest
- ② Harness buckle
- ③ Shoulder strap
- ④ Adjustment button
- ⑤ Cover of the headrest
- ⑥ Cover

1. Open the harness buckle **2**.
2. To loosen the belt, press the adjustment button **4** and pull both shoulder straps **3** forwards at the same time.

ⓘ The shoulder pads are **not** connected to the shoulder straps. If you pull on the shoulder pads, the belt is **not** loosened. Only pull on the shoulder straps.

3. Remove the seat insert (See "Remove seat insert", Page 7).
4. Fold the cover **5** of the headrest up.
5. Fold the cover **6** forwards.

4.3.3 Position the seat belt

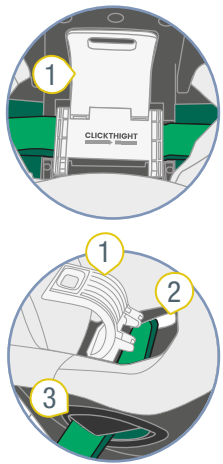

① Flap

② First belt guide

③ Second belt guide

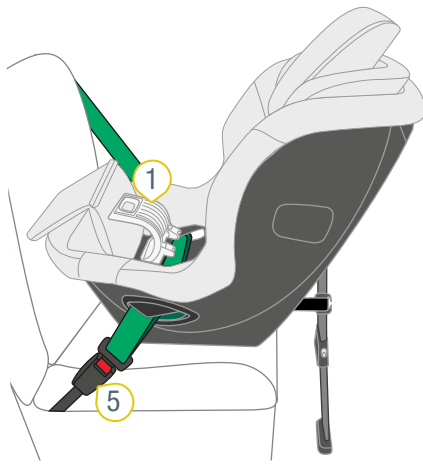

④ Harness buckle

⑤ Vehicle harness buckle

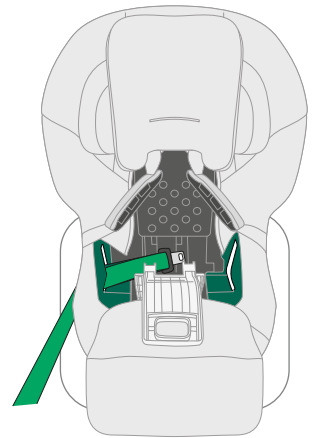
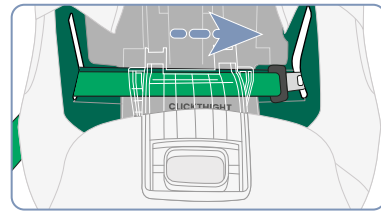
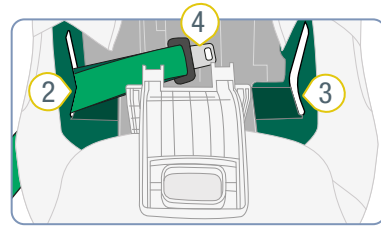
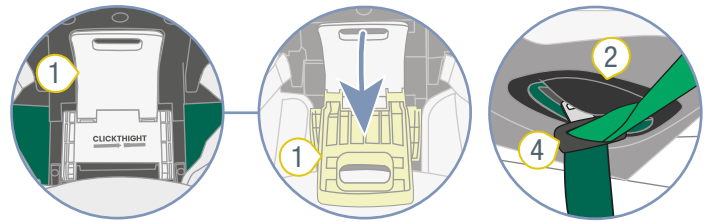

1. Open the flap 1.

TIP We recommend pulling the seat belt out one arm's length. This makes it easier to pass the seat belt through the child seat.

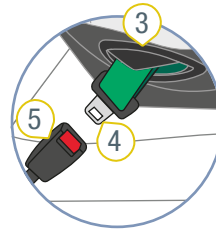

① Flap

② First belt guide

③ Second belt guide



④ Harness buckle

⑤ Vehicle harness buckle

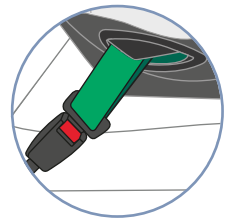

2. Pass the harness buckle 4 through the first belt guide 2.
3. Pass the harness buckle 4 under the flap 1.
4. Pass the harness buckle 4 through the second belt guide 3.
5. Engage the harness buckle 4 in the vehicle harness buckle 5.

4.3.4 Fasten the seat belt

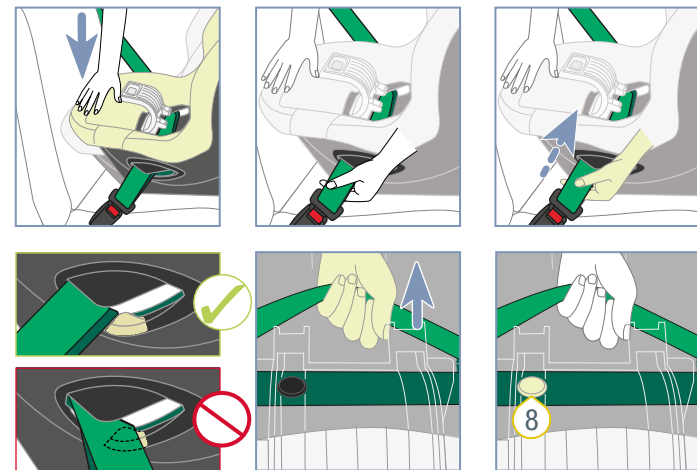
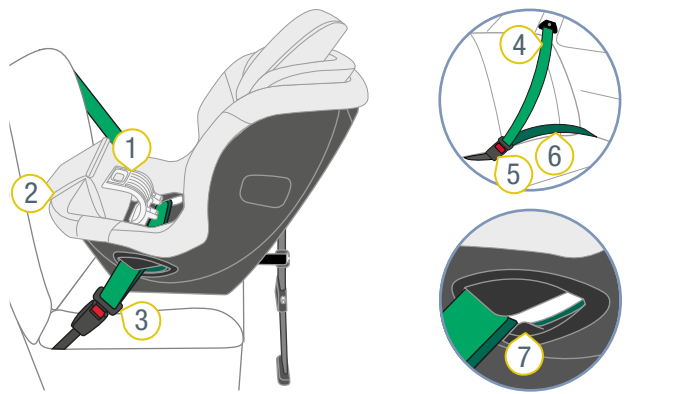

- ① Flap
- ② Foot end of the child seat
- ③ Harness buckle
- ④ Diagonal belt
- ⑤ Vehicle harness buckle
- ⑥ Lap belt
- ⑦ Belt limiter
- ⑧ Foreign part

1. Support yourself with one hand on the foot end **2** of the child seat. Keep the pressure on the foot end **2** until the last step,

i By supporting yourself, you are making sure that the child seat is tight to the vehicle cushion. This pre-tensioning is necessary in order to achieve a stable fastening with the seat belt.

2. Grab the diagonal belt **4** above the harness buckle **3** and hold it tight.
3. Tighten the lap belt **6** by pulling the diagonal belt **4**.
4. Make sure that neither side of the lap belt **6** is touching the belt limiter **7**.
5. Grab the diagonal belt **4** **in the middle of the child seat**.
6. Check that there are no foreign parts **8** of the seat belt in the area of the flap **1** or belt guides. If this is the case, slide the child seat sideways. Tighten the seat belt again.

TIP Foreign parts **8** can include, for example, rivets or loops.

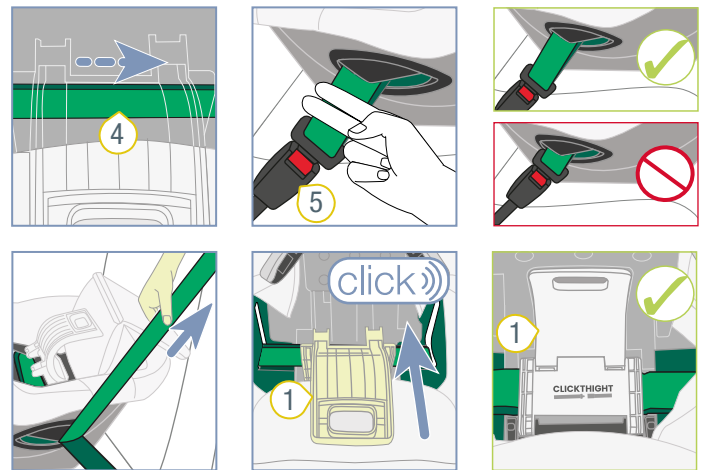

- ① Flap
- ④ Diagonal belt
- ⑤ Vehicle harness buckle

7. Tighten the seat belt by pulling the diagonal belt **4**.
8. Check that the vehicle harness buckle **5** is at least two finger-widths away from the belt guide. If this is the case, slide the child seat sideways. Tighten the seat belt again.
9. Grab the diagonal belt **4** **outside** the child seat.
10. Tighten the seat belt by pulling the diagonal belt **4**.
11. Fasten the seat belt by closing the flap **1**.
 - ✓ The flap engages audibly.
 - ✓ The seat belt is consistently tight.
 - ✓ The flap is closed.
 - ✓ The vehicle harness buckle is not touching the belt guide.
 - ✓ The seat belt is not located on the belt limiter.

4.3.5 Position the cover

1. Fold back the cover.
2. Fold down the cover of the headrest.
3. Attach the seat insert.

4.3.6 Setting support leg

i The support leg contains sensors. These support a correct fastening of the support leg. The sensors check whether the support leg is fully folded out, sufficiently extended and is on the floor. If the check is failed, a warning signal sounds. This indicates that the support leg is secured incorrectly.

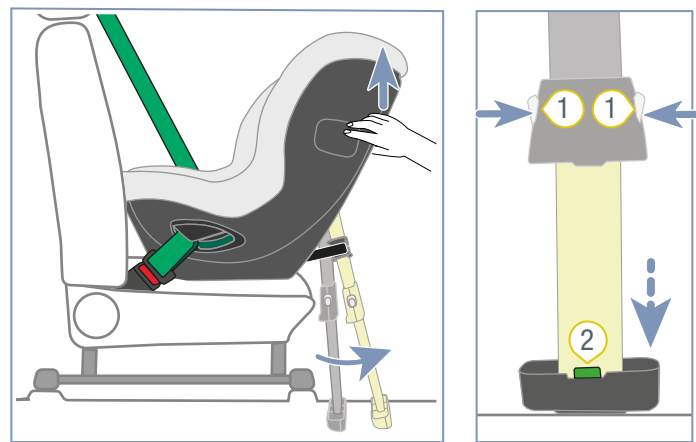
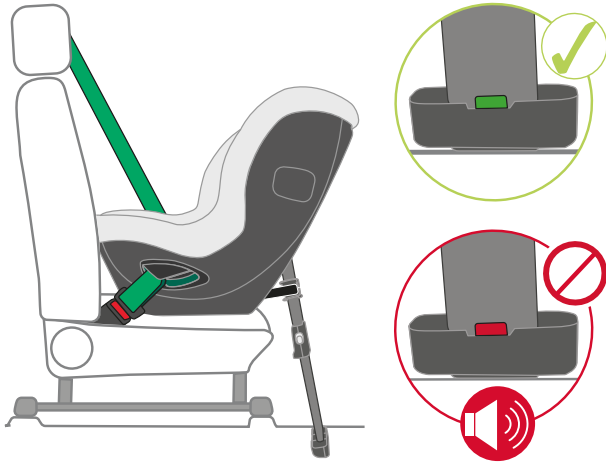

1 Adjustment buttons **2** Support indicator

1. Pull the film strips out of the battery compartment.
 - ✓ The warning signal sounds.
 - ⚠ CAUTION** If a signal cannot be heard, this means that the battery is empty.
 1. Regularly check the battery.
 2. Replace a used battery with a new one (See "Change battery", Page 19).
2. Pull the child seat slightly up against the backrest.
3. Fold the support leg completely away from the child seat.
 - ✓ The belts of the support leg are tight.
4. Press both adjustment buttons **1**.
 - ✓ The support leg extends to the floor.
5. Let go of the child seat and support leg.
 - ✓ Both adjustment buttons **1** audibly lock in place.
 - ✓ The protection indicator **2** is green.
 - ✓ The control signal cannot be heard.

⚠ WARNING Risk of injury if the support leg is not stable. **Never** place objects underneath the support leg. Make sure that the support leg is standing stably on the floor of the vehicle.

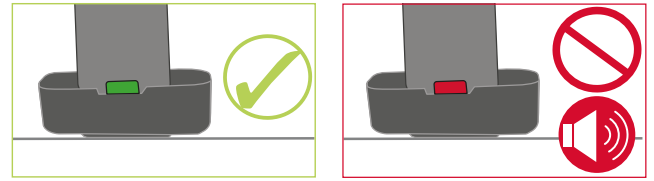

6. If the warning signal can still be heard or if the support indicator **2** is red, adjust the support leg again.

4.3.7 Fasten carabiner

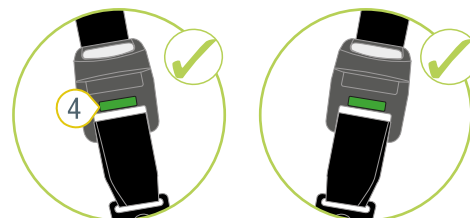
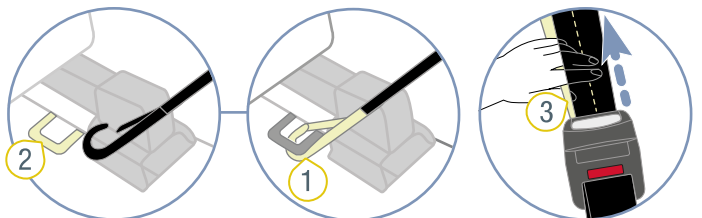
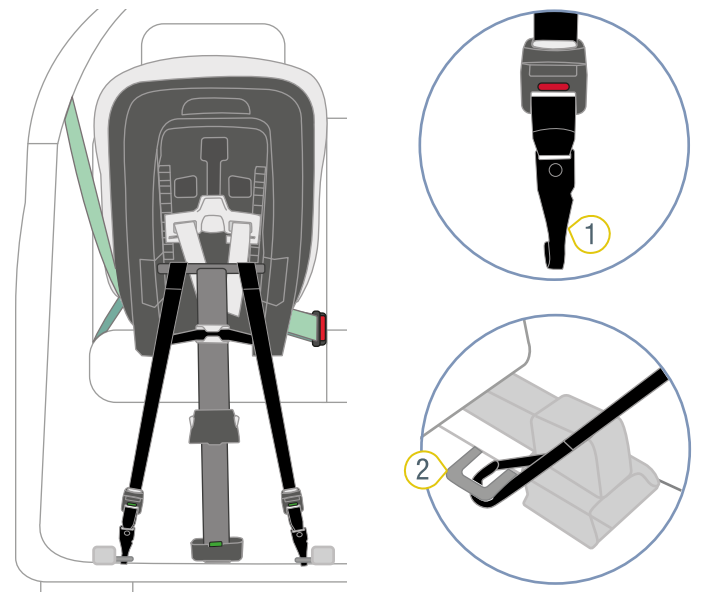

1 Carabiner **2** Eye **3** End of seat belt **4** Indicator

1. Hook the carabiner **1** into the defined eye **2**.
 - i** You have already specified the eyes in chapter "Prepare eyes", Page 8.
2. Tighten the end of the belt **3** until the indicator **4** of the lower strap is green.

- ✓ Both lower straps are tight.
- ✓ The indicator on lower strap is green.

4.4 Loosen child seat

WARNING

Risk of injury from unsecured objects

In the case of an emergency stop or accident, the unsecured child seat may cause injury to other occupants in the vehicle.

- ▶ Ensure that the child seat product is always secured when it is in the vehicle, even if no child is being transported.
-
- ▶ To remove the child seat from the car seat, follow the steps in chapter "Secure child seat", Page 11 in reverse order.

5 Buckling in and unbuckling

5.1 Buckle child in

⚠ WARNING

Risk of injury from front airbag

Airbags are designed to protect adults. The use of a front airbag when a seat is facing backwards can lead to serious or fatal injuries.

- ▶ Disable front airbag.
- ▶ **Never** use the seat facing backwards with an active front airbag.
- ▶ Note and observe the instructions in the vehicle handbook.

⚠ WARNING

Risk of injury from slack straps

Slack straps are areas of the seat belt that lie loosely against the child's body. Slack straps have a negative impact on the protective function.

- ▶ Ensure that the straps are tight and not twisted.
- ▶ The child should not wear thick clothing under the belt.

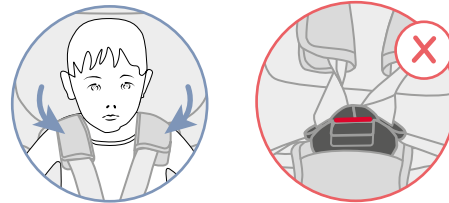
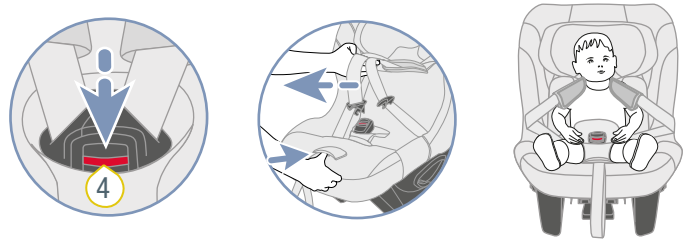
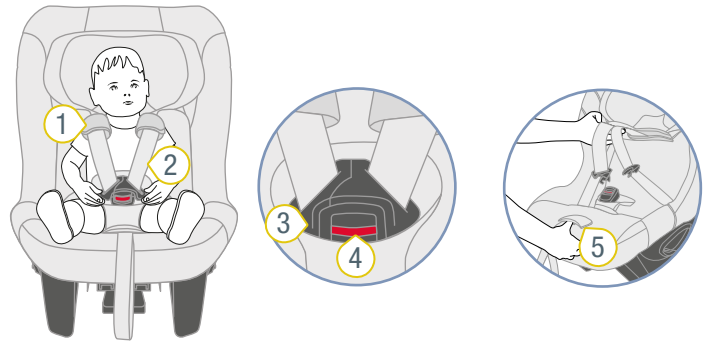

- ① Shoulder pads
- ② Shoulder straps
- ③ Harness buckle
- ④ Red button
- ⑤ Adjustment button

1. To loosen the belt, press the adjustment button **5** and pull both shoulder straps **2** forwards at the same time.
2. Open the harness buckle **3** by pressing the red button **4**.
3. Place the harness buckle **3** at the front.
4. Never leave the child unsupervised in the seat.
5. Place the shoulder straps **2** over the child's shoulders.

⚠ WARNING Risk of injury if child is secured incorrectly. Make sure that the shoulder straps are not twisted or reversed.



- ③ Harness buckle
- ④ Red button
- ⑤ Adjustment button
- ⑥ Buckle tongues
- ⑦ Adjustment belt

6. Bring the two buckle tongues **6** together.
7. Insert the joined buckle tongues **6** into the harness buckle **3**.

- ✓ The buckle tongues **6** audibly lock in place.
 - 8. To prevent slack straps, pull the shoulder straps **2**.
 - 9. Pull at the adjustment belt **7** until the shoulder straps **2** are tight to the child's body.
- ⚠ **WARNING** Risk of injury to the abdomen (soft area in the stomach). Ensure that the hip straps are positioned as low as possible over your child's hips.

5.2 Check before every use

To protect your child, check the following points before each car journey.

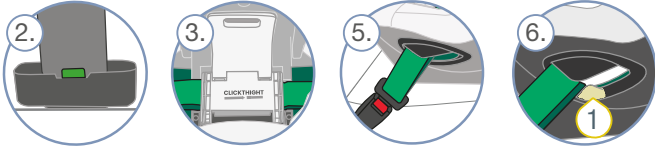

1. The support leg is stable on the floor of the car.
2. The support indicator of the support leg is green.
3. The flap is closed.
4. The seat belt is consistently tight.
5. The vehicle harness buckle is not touching the belt guide.
6. The seat belt is not located on the belt limiter.
7. The lower straps are fastened and tight.

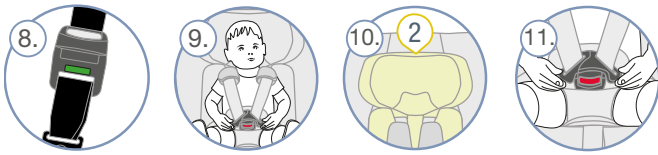

8. The green indicators of the lower straps are visible.
9. The straps are tight to the child's body without restricting the child.
10. The headrest is correctly adjusted.
11. The child is correctly strapped into the child seat.



12. The shoulder pads are in the right position on the child.
13. The straps are **not** twisted and **not** reversed.
14. The front airbag is disabled.
15. The child seat is used as intended in respect of the age and size of the child (See "Intended use", Page 4).

⚠ WARNING

Risk of injury due to omitted checks.

During the journey, the child may try to unbuckle the belt or loosen the child seat. If the child is not secured in the child seat, this can lead to serious or even fatal injuries.

If the child or the child seat is not fastened:

- ▶ Immediately stop the vehicle as soon as the traffic situation allows.
- ▶ Make sure that the child seat is secured.
- ▶ Ensure that the child is buckled in.

ⓘ For the wellbeing of your child, on long journeys we recommend taking regular breaks. Give your child the opportunity to move.

5.3 Unbuckle child

⚠ WARNING

Risk of injury from unsecured objects

In the case of an emergency stop or accident, the unsecured child seat may cause injury to other occupants in the vehicle.

- ▶ Ensure that the child seat product is always secured when it is in the vehicle, even if no child is being transported.

- ▶ To unbuckle the child, press the red button on the harness buckle.

ⓘ So that the child can get in easily before the next journey, loosen the shoulder straps.

6 Cleaning and maintenance

6.1 Harness buckle

6.1.1 Remove harness buckle

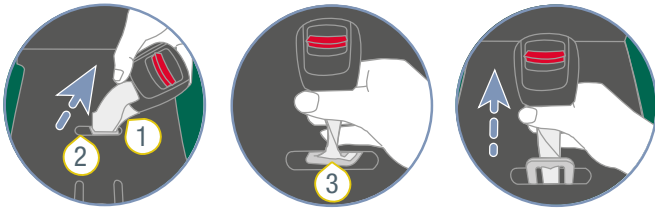

- ① Crotch strap
- ② Slot
- ③ Metal plate

- ▶ Remove the cover from the seat (See "Cover", Page 18).
- ▶ Rotate the crotch strap 1 with the metal plate 3 into the slot 2.
- ▶ Slide the narrow edge of the metal plate 3 forwards through the belt slot.

ⓘ The metal plate is located on the underside of the child seat, at the position of the harness buckle.

6.1.2 Clean belt lock

1. Soak the belt lock for at least an hour. Use warm water with washing-up liquid.
2. Thoroughly rinse and dry the harness buckle.

6.1.3 Attach harness buckle



- ① Slot
- ② Metal plate

1. Push the metal plate 2 from the front completely through the slot 1.
TIP Note the direction of the harness buckle.
2. Turn the crotch strap with the metal plate 2 by 90° until it is hooked into the slot 1 transversely to the direction of travel.

⚠ WARNING Risk of injury from unsecured harness buckle.

- ▶ Make sure that the harness buckle is securely fastened to the seat by forcefully pulling at it.
3. Attach the cover again (See "Cover", Page 18).

6.2 Cover

⚠ WARNING

Risk of injury due to missing parts

A secure hold is no longer guaranteed.

- ▶ The product must not be used without the seat cover.

6.2.1 Remove cover

ⓘ The cover of the child seat comprises multiple parts.

1. Loosen all fastenings.
2. Pull the individual parts of the cover from the child seat.

6.2.2 Clean cover

ⓘ You can remove the following covers and wash them in the washing machine:

- ▶ Cover of the headrest.
- ▶ Seat cover.
- ▶ Cover of harness buckle.

- ▶ Note the instructions on the cover's washing label.
- ▶ Wash the cover at 30 °C with a mild detergent on the washing machine's fine wash programme.
- ▶ You can remove the shoulder pads and wash them with like warm soapy water.
- ▶ You can clean the plastic parts and straps with soapy water.
- ▶ Do not use strong cleaning agents (such as solvents).

6.2.3 Attach cover

⚠ WARNING

Risk of injury due to missing seat cover

The seat cover is an integral safety component of the child seat. If the seat cover is not used, this may lead to serious or even fatal injuries.

- ▶ Never use the child seat without the correct seat cover.
- ▶ Only use the original Britax Römer replacement seat cover.
- ▶ Replacement seat covers are available from your retailer.

- ▶ To fit the cover again, follow the steps in the reverse order.

1. Loosen the cover **1**.
TIP The cover can be loosened with a coin.
2. Remove the used battery **2**.
3. Dispose the used battery **2** properly.
4. Insert a new battery **3** of type CR1632.
▲ WARNING Risk of injury from incorrect use
 - ▶ Never use a battery that has signs of a leak or bursting.
 - ▶ Do not expose the battery to high temperatures or fire. The battery can burst or explode.
 - ▶ Do not use rechargeable batteries.
 - ▶ Note the safety information on the battery's packaging.
5. Note the polarity alignment.

ⓘ Align the battery so that the minus pole faces the support leg.

6. Secure the cover **1**.

6.5 Troubleshooting

Harness buckle

The harness buckle is an integral part of the child seat and fulfils important functions for securing the child. Make sure that the harness buckle works perfectly.

Possible problems:

- The buckle tongues are only pushed out of slowly after pressing the red unlocking button.
- The buckle tongues no longer lock in place.
- The buckle tongues lock in place but not audibly.
- The buckle tongues can only be pushed into the harness buckle with difficulty.
- You need a lot of force to open the harness buckle.

Solution:

- ▶ Clean the harness buckle (See "Harness buckle", Page 18).

7 Storage and disposal

7.1 Storage

If you do not use the product for a longer period, please note the following information.

- ▶ Store product in a secure and dry location.
- ▶ Keep the storage temperature between 20 and 25 °C.
- ▶ Do not lean heavy objects on the product.
- ▶ Do not store product directly next to sources of heat or in direct sunlight.
- ▶ Protect the product from moisture, wet conditions, liquids, dust and salt spray.

7.2 Disposal

- ▶ Do not dismantle the product.
- ▶ Dispose of the battery in a container for batteries.



- ▶ Prevent third parties from using the defective product.
 - ① Cut through the shoulder straps.
 - Remove the approved label.
- ▶ Please follow the disposal regulations applying in your country.

8 Contact

If there are any questions, please get in touch:

BRITAX RÖMER Child Safety EMEA

www.britax-roemer.com

contact@britax.com

BRITAX RÖMER Kindersicherheit GmbH

Theodor-Heuss-Strasse 9

89340 Leipheim

Germany